

StreetWise™

ConstantColor™ CMH StreetWise™

NEW Generation Tubular Ceramic Metal Halide Lamps



DATA SHEET

Product information

Until now, public authorities and other organisations have had to choose between high cost, high quality outdoor illumination or low cost alternatives which, even at peak efficiency, make streets and other areas look dingy or dull.

GE's new generation of CMH StreetWise™ lamps especially designed for outdoor lighting offers the best of both worlds. Bright, white, 'natural' light and low costs for both running and maintenance.

With CMH lighting, streets and other public spaces can feel safer for pedestrians. More than that, their "daylight" colour rendering improves the ability of drivers to recognise shapes and colours, especially in peripheral vision. This also promotes quicker driver response times.

Features

- Very efficient, up to 110 lm/W
- Outstanding lumen maintenance, 80% at 12,000 hours
- Dimmable to achieve further energy saving, except 50W on electromagnetic ballast
- Direct retrofit to HPS
- Best white light alternative for mercury, HPS and standard ceramic solutions
- Long life 24,000 hours
- System flexibility - operates on both electronic and electromagnetic ballasts
- Lowest cost new system - standard base, standard ballast, standard optics
- Universal burning position (except 50W and 150W types)

Application areas



Road and Tunnel



Street and Pedestrian



Commercial areas / city beautification / architectural



Car Park

Product range

GE's new, feature-rich product range expands offerings both in new installations and replacements from 50-150W. Standard, robust base of E27 and E40 provides easy installation. The whole range delivers cost savings combined with excellent lamp quality characteristics and a long re-lamp cycle.



GE imagination at work

Specification summary

Wattage (W)	Colour	Normal Length [mm]	Product Description	CCT [K]	CRI [Ra]	Cap	Rated Average Life [h]	Pack Qty	Product Code
50/ECG	WDL	156	CMH50/TT/UVC/730/E27/ECG STREETWISE	3,000	70+	E27	24,000	12	64982
50/EM	WDL	156	CMH50/TT/UVC/730/E27/EM STREETWISE	3,150	67	E27	24,000	12	77400
70	WDL	156	CMH70/TT/UVC/730/E27 STREETWISE	3,000	70+	E27	24,000	12	77401
100	WDL	211	CMH100/TT/UVC/730/E40 STREETWISE	3,000	70+	E40	24,000	12	77399
150	WDL	211	CMH150/TT/UVC/730/E40 STREETWISE	3,000	68	E40	24,000	12	77402

General	Units	50W ECG	50W EM	70W	100W	150W
Product Code		64982	77400	77401	77399	77402
Rated Initial Lumens on Electronic Gear - Horizontal	[lm]	5,000	-	7,640	10,900	16,200
Rated Initial Lumens on Electronic Gear - Vertical	[lm]	-	-	7,100	10,300	-
Rated Wattage (ECG)	[W]	50	-	73	100	147
Rated Wattage (EM)	[W]	-	52	71	98	150
Weighted Energy Consumption	[kWh/1000hrs]	55.00	57.20	78.10	107.80	165.00
Rated Initial Lumens on Magnetic Gear - Horizontal	[lm]	-	4,650	7,250	10,200	16,300
Rated Initial Lumens on Magnetic Gear - Vertical	[lm]	-	-	7,000	10,000	-
Rated Efficacy on Electronic Gear - Horizontal	[LpW]	100	-	104.6	109	110.2
Rated Efficacy on Electronic Gear - Vertical	[LpW]	-	-	99	103	-
Rated Efficacy on Magnetic Gear - Horizontal	[LpW]	-	90	102	104	109
Rated Efficacy on Magnetic Gear - Vertical	[LpW]	-	-	98	102	-
Energy Efficiency Class	[EEC]	A+	A+	A+	A+	A+
Colour Temperature EM/ECG	[K]	3,050	3,150	3,050/2,900	3,050/2,900	3,050/2,900
Colour Rendering Index (ECG)	[Ra]	70+	67 (EM)	70+	70+	68
Colour Rendering Index at 70% Power	[Ra]	65+	-	65+	65+	65+
Ambient Temperature	[°C]	25	25	25	25	25

Starting Characteristics¹

Time To Start	[s]	< 30	< 30	< 30	< 30	< 30
Hot Restart Time (Maximum)	[min.]	15	15	15	15	15

¹ Typical values (actual values will be ballast dependent)

Through Life Performance - Horizontal operation

Lumen Maintenance At 12000 Hrs (% Of Initial Lumens)	%	80	80	80	80	80
Rated Life Horizontal B5	[h]	13,500	9,500	9,500	13,500	9,500
Rated Life Horizontal B10	[h]	16,500	12,000	12,000	16,000	12,000
Rated Life Horizontal B20	[h]	18,800	15,800	15,800	18,800	15,800
Average Rated Life Horizontal B50	[h]	24,000	24,000	24,000	24,000	24,000

Through Life Performance - Vertical Operation

Lumen Maintenance At 12 000 Hrs (% of Initial Lumens)	%	-	-	80	80	-
Rated Life Vertical B5	[h]	-	-	5,700	5,700	-
Rated Life Vertical B10	[h]	-	-	8,000	8,000	-
Rated Life Vertical B20	[h]	-	-	11,500	11,500	-
Average Rated Life Vertical B50	[h]	-	-	20,000	20,000	-

Safety Requirements

Maximum Allowed Bulb Temperature Under Abnormal Conditions ²	[°C]	320	320	320	400	400
Maximum Base Temperature	[°C]	210	210	210	250	250

² For a bare lamp running at 1.25 x normal operating power to simulate the most unfavourable conditions of high line voltage and low ballast impedance in a fixture environment.
*Rated life at launch, life tests are ongoing.

Luminaire Characteristics	Enclosed	Enclosed	Enclosed	Enclosed	Enclosed
----------------------------------	----------	----------	----------	----------	----------

Note that the lamp voltage inside the luminaire should not deviate by more than 5V from the bare lamp voltage in free air. Thermal protection recommended

Electrical Characteristics

Operating Position		Horizontal	Horizontal	Universal	Universal	Horizontal
Lamp Power (Rated)	[W]	50	52	72	97	150
Lamp Voltage - Horizontal	[V]	80	85	95	100	100
Lamp Voltage - Vertical	[V]	-	-	90	95	-
Lamp Current	[A]	0.62	0.76	0.95	1.16	1.8
Max. Ignition Voltage	[kV]	5	5	5	5	5
Conventional Ballast Required	[W]	-	HPS ballast and HPS ignitor	HPS ballast and HPS ignitor	HPS ballast and HPS ignitor	HPS ballast and HPS ignitor
Ballast Impedance at 230V	[V/A]	257	257	197	155	106
Power Factor Correction Capacitor	[uF]	-	8	10	12	20
Mercury Content	[mg]	11.0	13.2	13.5	13.2	13.9

Dimensions

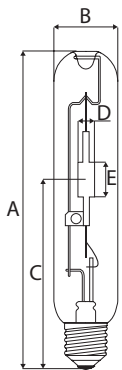

		50 W ECG Tubular	50 W EM Tubular	70 W Tubular	100 W Tubular	150 W Tubular
Product Code		64982	77400	77401	77399	77402
A – lamp MOL	[mm]	154±2 (max. 156)	154±2 (max. 156)	154±2 (max. 156)	209±2 (max. 211)	209±2 (max. 211)
B – bulb diameter max.	[mm]	39	39	39	48	48
C – lamp LCL nominal	[mm]	102	102	102	132	132
D – lamp LCL nominal	[mm]	5.8	6.7	6.7	8.1	9.6
E – burner height	[mm]	13.4	17.5	17.5	17.7	23.3
Arc tube eccentricity	[°]	3	3	3	3	3
Base type		E27	E27	E27	E40	E40

Lamp life

Life survival graph is shown for statistically representative batches of lamps operated under controlled nominal conditions with an 11 hours per start switching cycle. The declared lamp life is the median life, which is when 50% of the lamps from a large sample batch would have failed. Lamp life in service will be affected by a number of parameters, such as supply voltage variation, switching cycle, operating position, mechanical vibration, luminaire design and control gear. The information is intended to be a practical guide for comparison with other lamp types. The determination of lamp replacement schedules will depend upon the acceptable reduction in illuminance and the relative costs of spot and group replacement.

Note: 50W lamps were measured on both ECG and EM. 70-150W lamps were measured on an electronic ballast but data is valid for both ECG and EM.

Lamp survival CMH Streetwise™ 50W ECG & 100W

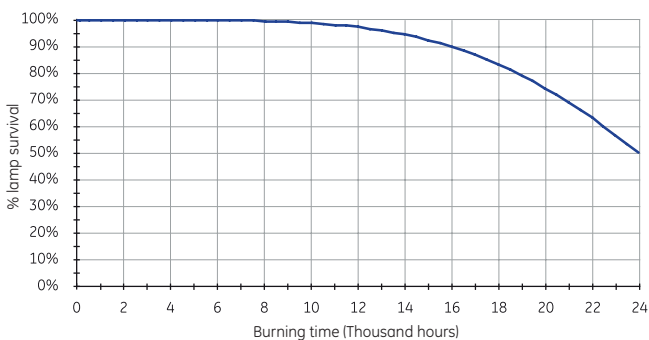

Lamp survival CMH Streetwise™ 50W EM, 70W & 100W

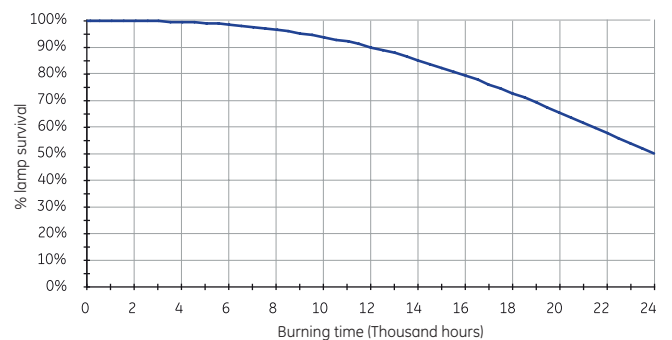

Lamp survival CMH Streetwise™ 70W & 100W Vertical burning

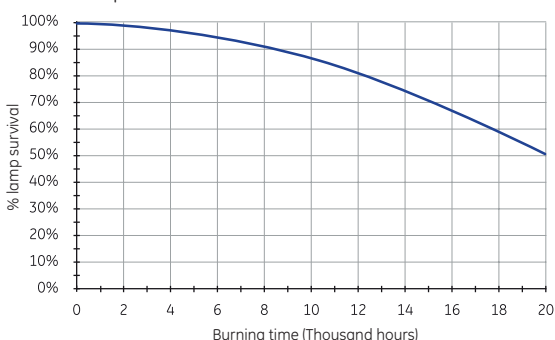

Lumen maintenance

The lumen maintenance graph shows how the luminous output decreases throughout life. All metal halide lamps experience a reduction in light output and a very slight increase in power consumption through life. Consequently there is an economic life when the efficacy of the lamp falls to a level at which is better to replace the lamp and restore the illumination. Where a number of lamps are used within the same area it may be well worth considering a group lamp replacement programme to ensure uniform output from all the lamps. Curves are representing 11 hours per start cycle, less frequent starting will improve lumen maintenance.

Note: Representative curves are for horizontal orientation and measured on an electronic ballast.

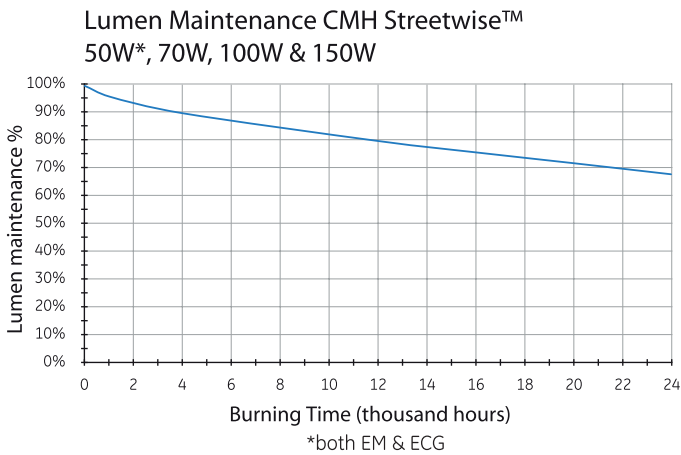

Spectral power distribution

Representative spectral power distribution curve is provided in the following diagram.

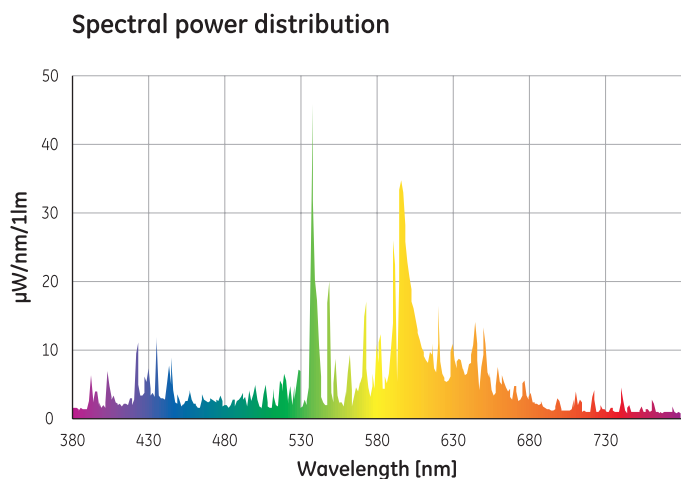

Distribution of luminous intensity

The following diagrams show polar light intensity curves for lamp base-up orientation:

StreetWise™ 50W

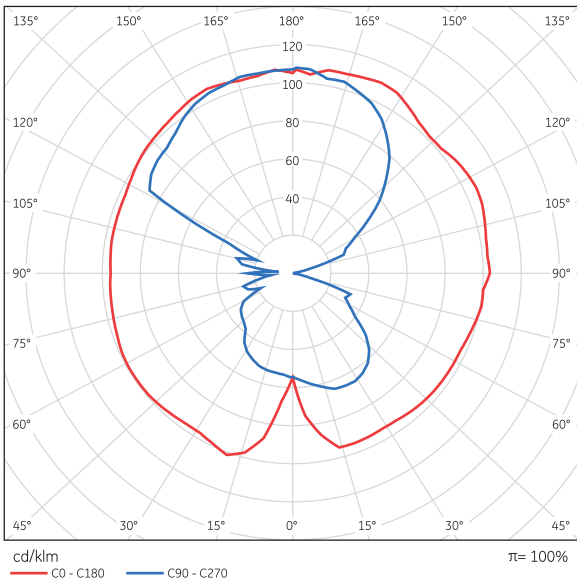

StreetWise™ 70W

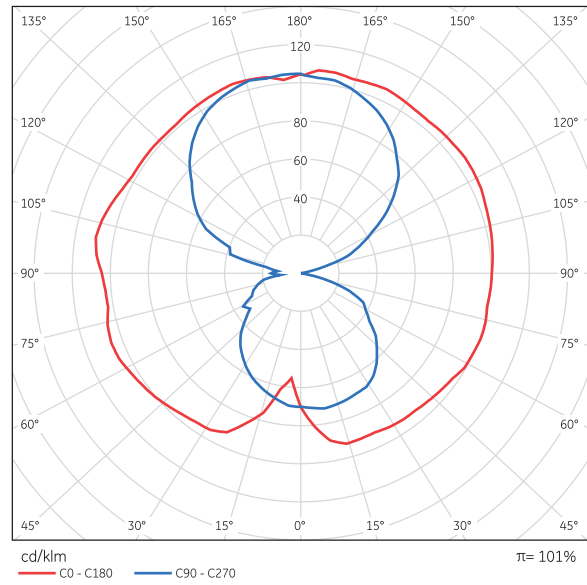

StreetWise™ 100W

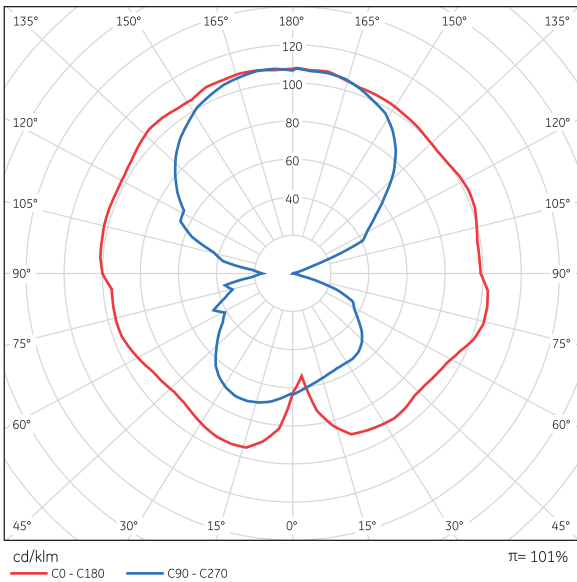

StreetWise™ 150W

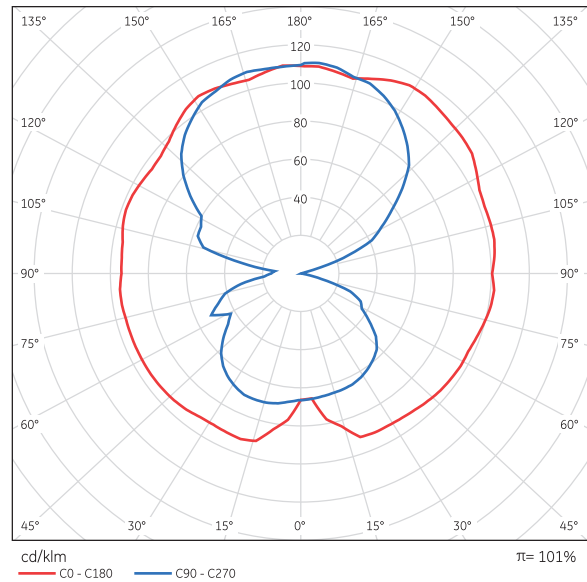

Warm-up characteristics

During the warm-up period immediately after starting, lamp temperature increases rapidly and mercury as well as the metal halides evaporate within the arc tube. The lamp current and voltage will stabilise in less than 4 minutes. During this period the light output will increase from zero and the colour will approach the correct visual effect as each metallic element becomes vaporised.

Typical warm-up characteristics
50w, 70W, 100W, 150W StreetWise™ lamps

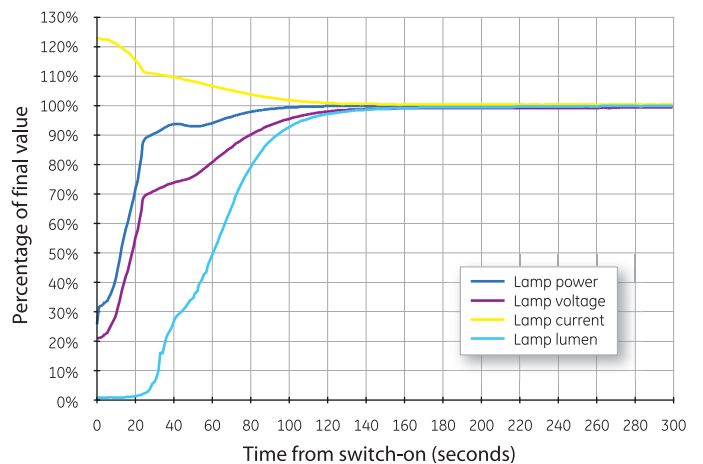

Supply voltage sensitivity

The line supply voltage applied to the control gear should be as close to rated nominal as possible. Lamps will start and operate at 10% below rated supply voltage but this should not be considered as a normal operating condition. In order to maximise lamp survival, lumen maintenance and colour uniformity, supply voltage and rated ballast voltage should be within $\pm 3\%$. Supply variations of $\pm 5\%$ are permissible for short periods only. Where supply voltage variation is likely to occur the use of electronic control gear should be considered as this type of equipment is normally designed to function correctly for a voltage range of 200-240V.

Dimming

There is an increasing demand to maximise energy savings of light sources. While HID lamps are inherently very efficient, many users would like to further increase the energy savings of HID lamps through dimming.

Dimming systems that maintain the open circuit voltage to the lamp (such as magnetic systems with variable impedance, or electronic square wave ballasts with dimming function) can be approved for standard life warranty with dimming down to 65% power. The lumen maintenance and colour appearance may be substantially affected when dimming down to 50% of rated power.

Each lamp in the CMH StreetWise™ range can be dimmed up to 65% of its rated power with the exception of CMH50/TT/UVC/730/E27/EM STREETWISE (77400). This means that the operating power of the lamp can be reduced below its nominal rating. This greatly increases installation flexibility and opportunities to reduce energy costs through the operational cycle of the application.

The reliability and lumen maintenance of the CMH Streetwise™ lamps are not affected by dimming operation. The colour performance of lamps in the StreetWise™ range is such that CCT and Ra are similar when dimmed at similar relative % powers. This means that lamps may be mixed in implementation and operated on the same dimming circuit with appealing overall appearance.

- Dimming ballasts start at full power, remain there for 15 minutes, and then the lamps may be dimmed.
- Dimming is supported on electronic ballasts or magnetic systems that can maintain the open circuit voltage.
- When a StreetWise™ lamp is dimmed, approximately: 90% power = 90% rated lumens; 80% power = 75% rated lumens; 70% power = 65% rated lumens; 60% power = 50% rated lumens
- The colour rendering of CMH Streetwise™ lamps is 70 at full power and about 65 at 65% power.
- The CCT of CMH StreetWise™ lamps increases by about 400K when dimmed to 65% power.

Dimming systems that reduce line voltage: down to 85% of line voltage is acceptable with StreetWise lamps on a typical reactor ballast. In this case the light output will be reduced by about 35%, with about 25% system energy savings. Line voltage dimming may shorten the life of the lamps.

For such systems, it is important to reduce the line voltage slowly to avoid premature lamp cycling, especially with older lamps that are already high in voltage and close to the normal dropout point.

In changing from the full-power mode to the reduced-power mode, the time between full power and reduced power must be no less than ninety seconds, and the rate of change of power at any power level between full power and reduced power must be no greater than that corresponding to a linear (uniform) reduction between those extremes in a ninety-second time interval.

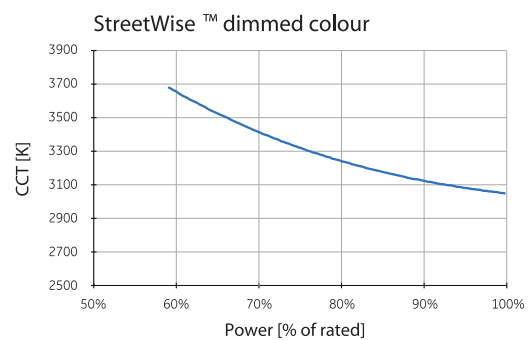
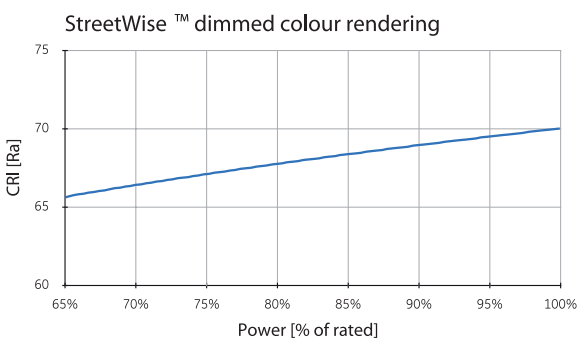

End of life conditions

The principal end of life failure mechanism for CMH lamps is arc tube leakage into the outer jacket. At the high operating temperatures inside the arc tube, the corrosive dose material can eventually cause leakage after a long period of time. Arc tube leakage into the outer jacket can be noticed by a sudden significant lumen drop and a perceptible color change (the color usually turns green).

IEC 60662 and IEC 62035 warn of a risk that at the end of lamp life a number of lamps may exhibit a rectifying effect. Thermally protected ballasts or ballasts resistant to rectification are recommended by GE Lighting.

See Fusing Recommendations.

UV and damage to sensitive materials

The wall of the bulb, which is produced with specially developed 'UV Control' material, absorbs potentially harmful high energy UV radiation emitted by the ceramic arc tube.

The use of UV control material together with an optically neutral front glass cover allows the lamp to significantly reduce the risk of discolouration or fading of products. Luminaires should not be used if the front glass is broken or missing. It is recommended that a safety interlock switch is incorporated into the luminaire to prevent operation when the luminaire is opened.

Finally the selection of luminaire materials should take into consideration the UV emission. Current UV reduction types on the market are optimised for UV safety of human eye and skin exposure. However, luminaire materials may have different wavelength dependent response functions. Designers must take account of emission in each of the UV-A, UV-B and UV-C spectral ranges as well as material temperatures when designing luminaires.

Information on luminaire design

Ballasts

ConstantColor™ CMH operate from the same ballast impedance as conventional High Pressure Sodium systems. The use of thermal protection or ballast protection is good practice for these lamps. This safety device will protect the circuit at end of lamp life should partial rectification occur due to electrode imbalance or arc tube failure.

Stray magnetic field of conventional ballast

At the design stage for fixtures incorporating the control gear, careful consideration should be given to the physical layout of the lamp and ballast. The relative positions and distance between lamp and ballast can adversely affect lamp performance and drastically reduce lamp life survival.

Conventional magnetic ballasts can produce a stray magnetic field and if the lamp is placed within this field, "bowing" of the arc in the discharge tube can occur. Since ceramic is a very rigid material severe arc bowing can cause high thermal stress leading to cracking or rupture of the arc tube resulting in failure of the lamp early in life.

In fixtures where the ballast is necessarily placed close to the lamp, use of magnetic shielding is essential. Another solution is to use an electronic ballast, which eliminates the need for an ignitor, simplifies wiring, reduces the risk of stray magnetic field and eliminates light output flicker.

Containment requirement

ConstantColor™ CMH lamps operate above atmospheric pressure, therefore a very small risk exists that the lamp may shatter when the end of life is reached. Though this failure mode is unlikely, containment of shattered particles is required as defined by IEC 62035.

Single-ended lamps should only be used in a suitable enclosed luminaire with front cover glass capable of containing the fragments of a lamp should it shatter

Control gear and accessories

Electronic ballasts

StreetWise™ lamps can be operated both on electronic and electromagnetic ballasts.

Advantages of electronic ballasts are:

- Good regulation against supply voltage variation
- Reduced weight of control gear
- Reduced electrical power losses
- Ballast noise reduced/eliminated
- Single piece compact unit
- Reduced wiring complexity in the luminaire

System Performance on electronic ballast (estimated)		50W	70W	100W	150W
System Power	W	55	79	108	158
System Efficacy	lm/W	91	97	101	102.5
Lumens	lm	5,000	7,640	10,900	16,200
Lamp Power	W	50	73	100	147
Lamp Efficacy	lm/W	1,000	105	100	100.2
Lamp Voltage Range	V	67-87	77-97	84-104	84-104

Electronic ballast circuitry

The ballasts should comply with the relevant parts of the following standards:

- RFI suppression EN 55015
- Harmonics EN 61000-3-2
- Immunity EN 61547
- Safety EN 60926/EN 60928/EN 61347
- Performance EN 60927/EN 60929

Note: GE Lighting can test electronic gear for compatibility. For specific requests please contact your local representative or visit www.gelighting.com.

Suitable ignitors

Operating on both HPS and Metal halide lamp ignitors with minimum requirements: 1 pulse/half cycle, 30 second ignition time and compliant to the related ignition specification in HPS IEC60662 performance standard (for HPS types).

Superimposed ignitors

In many installations Ceramic Metal Halide lamps are operated from a conventional magnetic ballast in conjunction with a superimposed ignitor. These ignitors generate starting pulses independently from the ballast and should be placed close to the lamp, preferably within the luminaire. Wiring between ignitor and lamp should have a maximum capacitance to earth of 100pF (length equivalent to less than 1 Metre) – contact ignitor manufacturer for details of specific ignitor types. A typical circuit diagram is shown.

Impulser ignitors

Impulser type ignitors use the ballast winding as a pulse transformer and can only be used with a matched ballast. Always check with the ballast and ignitor supplier that components are compatible. Longer cable lengths between ballast & ignitor and the lamp are possible due to the lower pulse frequency generated, giving greater flexibility for remote control gear applications. Ignitor pulse characteristics at the lamp must however comply with specified minimum values for ConstantColor™ CMH lamps under all conditions.

Typical superimposed ignitor circuit

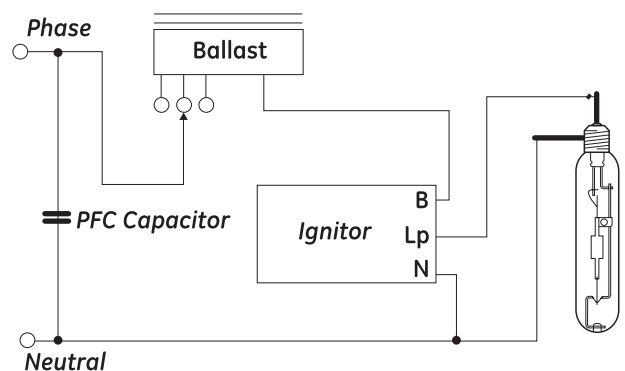

Typical impulser ignitor circuit

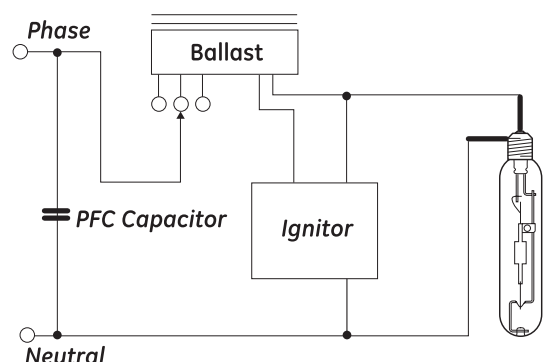

Other ignitor related considerations

Timed or cut-out ignitors

The use of a 'timed' or 'cut-out' ignitor is not a specific requirement for ConstantColor™ CMH lamps but it is a good optional safety feature worth considering to protect the ignitor from overheating and to prolong its life. If used, the timed period must be adequate to allow lamps to cool and restart as described in the previous section. A period of 10-15 minutes continuous or intermittent operation is recommended before the ignitor automatically switches off. Timed ignitors specifically offered for High-Pressure Sodium lamps where the period of operation is only about 5 minutes are not suitable for ConstantColor™ CMH lamps.

Warm re-starting

The combined characteristics of ceramic arc tube material and vacuum outer jacket result in ConstantColor™ CMH lamps cooling relatively slowly. It is possible with low energy ignitors to reach the required breakdown voltage but not create a full thermionic discharge. Under these conditions the lamp can remain very warm and be prevented from cooling to a temperature at which the arc can be re-established. To avoid this, turn off the power supply for approximately fifteen minutes or change to a suitable high energy ignitor from the list given in the superimposed ignitor section.

Fusing recommendations

For a very short period immediately after switch-on, all discharge lamps can act as a partial rectifier and the ballast may allow higher than the normal current to flow. In order to prevent nuisance fuse failure the fuse ratings must take account of this.

See relevant information on national installation requirements for High Intensity Discharge lighting circuits.

Single fusing is recommended which gives added protection for the end-of-life condition when partial rectification can also occur. HBC or MCB (type 3 or 4) fuse ratings for single and multiple lamp installations.

Number of Lamps	1	2	3	4	5	6
50W Fuse Rating [A]	4	4	6	6	10	10
70W Fuse Rating [A]	4	4	6	6	10	10
100W Fuse Rating [A]	4	4	6	10	10	10
150W Fuse Rating [A]	4	6	10	10	16	16

Safety warnings

The use of these products requires awareness of the following safety issues:

Warning:

- Risk of electric shock - isolate from power before changing lamp
- Strong magnetic may impair lamp performance, and in the worst case could lead to lamp rupture

Use in enclosed fixtures to avoid the following:

- Risk of fire
- A damaged lamp emits UV radiation which may cause eye/skin injury, remove and dispose of broken lamp
- Unexpected lamp rupture may cause injury, or property damage, use in luminaire with front cover made of glass

Caution:

- Risk of burn, allow lamp to cool before handling
- Lamp may shatter and cause injury if broken

Always follow the supplied lamp operation and handling instructions.